

Product Overview

The Qorvo T2G6000528-Q3 is a 10W (P_{3dB}) discrete GaN on SiC HEMT which operates from DC to 6 GHz. The device features advanced field plate techniques to optimize power and efficiency at high drain bias operating conditions. This optimization can potentially lower system costs in terms of fewer amplifier line-ups and lower thermal management costs.

Lead-free and ROHS compliant

Evaluation boards are available upon request.



Key Features

- Frequency: DC to 6 GHz
- Output Power (P_{3dB})¹: 9.5 W
- Linear Gain¹: 18 dB
- Typical DE_{3dB} ¹: 70%
- Operating Voltage: 28 V
- Low thermal resistance package
- Pulse capable

Notes:

1. @ 3.0 GHz

Functional Block Diagram

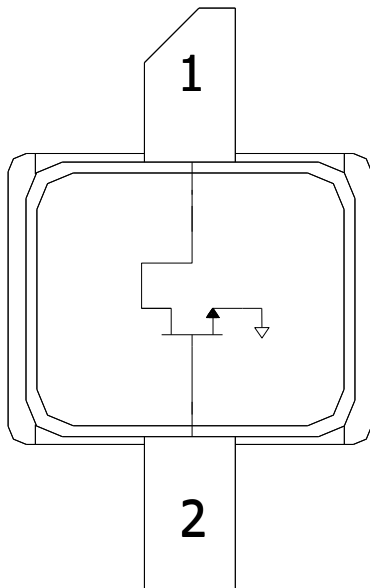

Applications

- Military Radar
- Civilian Radar
- Professional and military radio communications
- Test Instrumentation
- Wideband or narrowband amplifiers
- Jammers

Ordering Information

Part Number	Description
1099997	T2G6000528-Q3, Qty. 100
1099999	T2G6000528-Q3 3.0 – 3.5 GHz EVB
1125393	T2G6000528-Q3 1.9 – 3.2 GHz EVB
1139251	T2G6000528-Q3 5.0 – 6.0 GHz EVB
T2G6000528Q3EVB03	T2G6000528-Q3 3.5 – 4.3 GHz EVB

Absolute Maximum Ratings¹

Parameter	Rating	Units
Breakdown Voltage (V_{D0})	+100	V
Gate Voltage (V_G)	-7 to +2	V
Drain Current (I_D)	2.5	A
Gate Current Range (I_G)	See page 4	mA
Power Dissipation (P_D) ²	15	W
RF Input Power (RF_{IN}) ³	34	dBm
Mounting Temperature (30 seconds)	320	°C
Storage Temperature	-65 to +150	°C

Notes:

1. Operation of this device outside the parameter ranges given above may cause permanent damage.
2. Pulsed CW: Pulse Width = 500 μ s, Duty Cycle = 20%
3. Signal Type: CW, T = 25 °C

Recommended Operating Conditions¹

Parameter	Min	TYP	Max	Units
Operating Temperature	-40	+25	+85	°C
Drain Voltage (V_D)	+12	+28	+40	V
Drain Bias Current (I_{DQ})	-	50	-	mA
Drain Current (I_D)	-	650	-	mA
Gate Voltage (V_G) ⁴	-	-2.7	-	V
Power Dissipation (P_D) ²	-	-	11	W
Power Dissipation (P_D) ³	-	-	12.5	W

Notes:

1. Electrical performance is measured under conditions noted in the electrical specifications table. Specifications are not guaranteed over all recommended operating conditions.
2. Signal Type: CW, Package base at 85°C
3. Pulsed CW: Pulse Width = 100 μ s, Duty Cycle = 20% Package base at 85°C
4. To be adjusted to desired I_{DQ}

Pulsed Characterization – Load Pull Performance – Power Tuned¹

Parameters	Typical Values						Unit
	1.0	2.0	3.0	4.0	5.0	6.0	
Frequency	1.0	2.0	3.0	4.0	5.0	6.0	GHz
Linear Gain (G_{LIN})	18.1	20.8	18.1	16.6	14.8	14.5	dB
Output Power at 3dB Compression (P_{3dB})	7.6	9.1	9.5	10	11	10	W
Drain Efficiency at 3dB Compression (DE_{3dB})	54.3	61.5	53.7	60.0	60.6	58.8	%
Gain at 3dB Compression (G_{3dB})	15.1	17.8	15.1	13.6	11.8	11.5	dB

Notes:

1. Test conditions unless otherwise noted: $V_D = +28$ V, $I_{DQ} = 50$ mA, $T_A = +25$ °C

Pulsed Characterization – Load Pull Performance – Efficiency Tuned¹

Parameters	Typical Values						Unit
	1.0	2.0	3.0	4.0	5.0	6.0	
Frequency	1.0	2.0	3.0	4.0	5.0	6.0	GHz
Linear Gain (G_{LIN})	22.3	21.2	18.7	17.3	15.3	15.2	dB
Output Power at 3dB Compression (P_{3dB})	5.4	7.8	5.9	7.8	7.8	6.6	W
Drain Efficiency at 3dB Compression (DE_{3dB})	81.9	72.2	69.6	66.1	70.7	66.8	%
Gain at 3dB Compression (G_{3dB})	19.3	18.2	15.7	14.3	12.3	12.2	dB

Notes:

1. Test conditions unless otherwise noted: $V_D = +28$ V, $I_{DQ} = 50$ mA, $T_A = +25$ °C

RF Characterization – 3.0 – 3.5 GHz EVB Performance at 3.3 GHz¹

Parameters	Min	Typical	Max	Units
Linear Gain (G_{LIN})	15.5	17.4	-	dB
Output Power at 3dB Compression (P_{3dB})	8.9	9.7	-	W
Power-Added-Efficiency at 3dB Compression (DE_{3dB})	50	53.0	-	%
Gain at 3dB Compression (G_{3dB})	12.5	14.4	-	dB
Gate Leakage (I_{G-Leak}) ²	-0.1	-	-2.75	mA

Notes:

1. Test conditions unless otherwise noted: $V_D = +28$ V, $I_{DQ} = 50$ mA, $T_A = +25$ °C, Pulsed Width = 100 μ s, Duty Cycle = 20%
2. $V_D = 10$ V, $V_G = -3.7$ V, Signal Type: DC

RF Characterization – Mismatch Ruggedness at 3.5 GHz¹

Symbol	Parameter	dB Compression	Typical
VSWR	Impedance Mismatch Ruggedness	3	10:1

Notes:

1. Test conditions unless otherwise noted: $V_D = +28$ V, $I_{DQ} = 50$ mA, $T_A = +25$ °C, Pulse Width = 100 μ s, Duty Cycle = 20%
2. Driving input power is determined at pulsed compression under matched condition at EVB output connector.

Maximum Gate Current

Maximum Gate Current Vs. Peak IR Surface Temperature

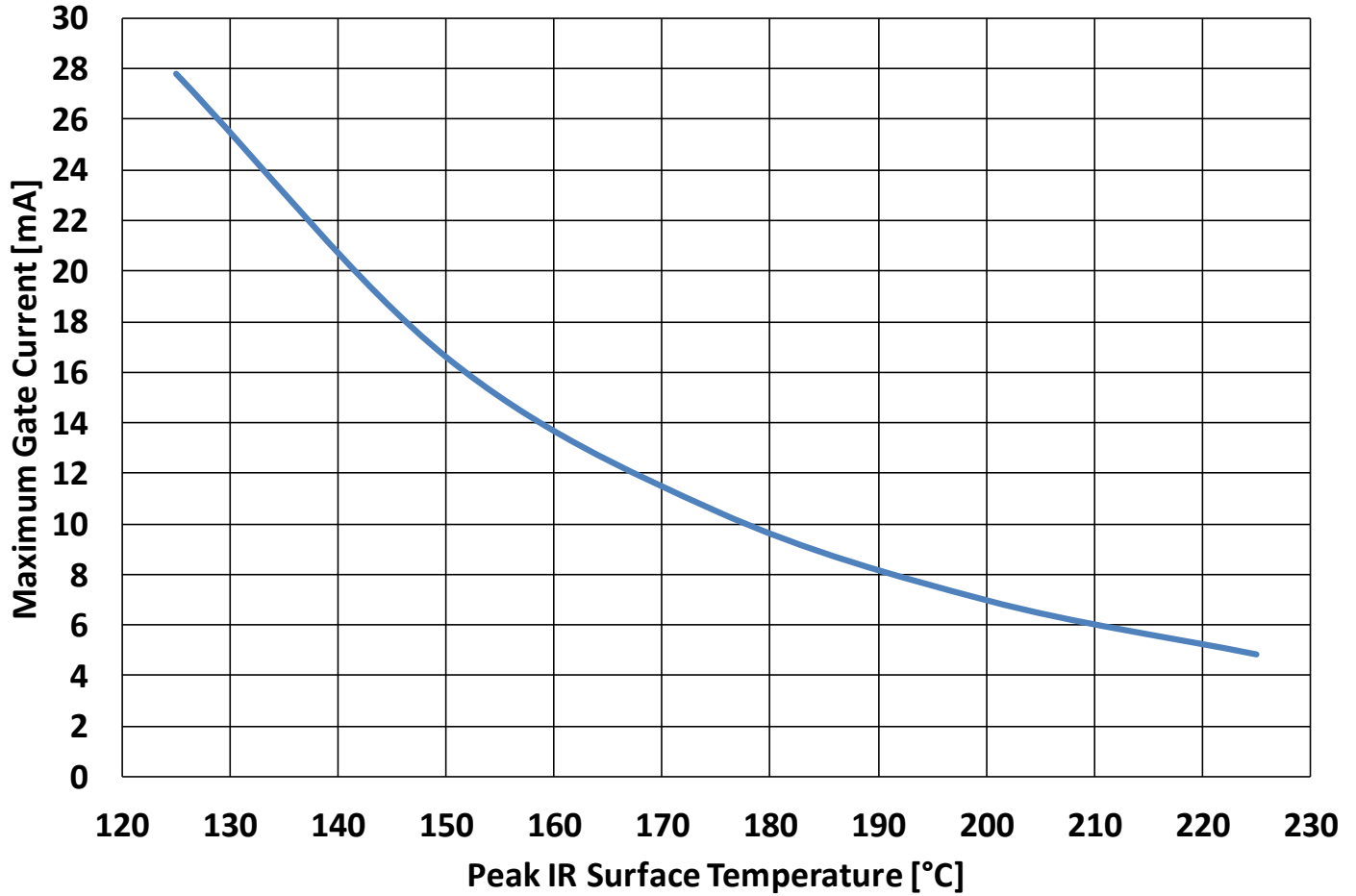

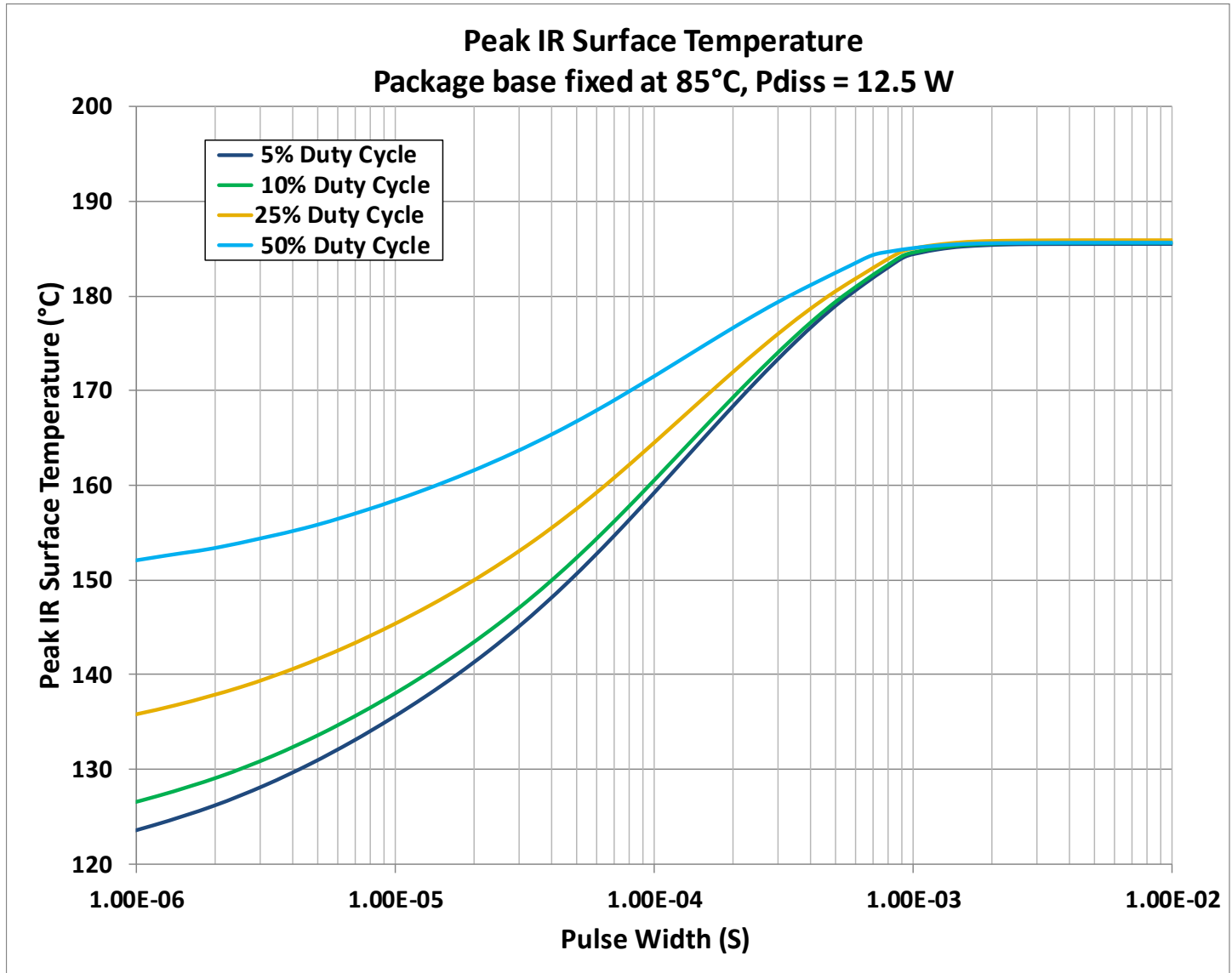
Thermal and Reliability Information – Pulsed

Parameter	Conditions	Values	Units
Thermal Resistance, IR ¹ (θ_{JC})	85 °C back side temperature	5.9	°C/W
Peak IR Surface Temperature ¹ (T_{CH})	12.5 W P _D , Pulse Width = 100 μ s, Duty Cycle = 5%	159	°C
Thermal Resistance, IR ¹ (θ_{JC})	85 °C back side temperature	6.1	°C/W
Peak IR Surface Temperature ¹ (T_{CH})	12.5 W P _D , Pulse Width = 100 μ s, Duty Cycle = 10%	161	°C
Thermal Resistance, IR ¹ (θ_{JC})	85 °C back side temperature	6.3	°C/W
Peak IR Surface Temperature ¹ (T_{CH})	12.5 W P _D , Pulse Width = 100 μ s, Duty Cycle = 25%	164	°C
Thermal Resistance, IR ¹ (θ_{JC})	85 °C back side temperature	7.0	°C/W
Peak IR Surface Temperature ¹ (T_{CH})	12.5 W P _D , Pulse Width = 100 μ s, Duty Cycle = 50%	172	°C

Notes:

1. Refer to the following document [GaN Device Channel Temperature, Thermal Resistance, and Reliability Estimates](#)

Thermal and Reliability Information – Pulsed

Peak IR Surface Temperature vs. Dissipation Power
Base Temperature Fixed at 85°C

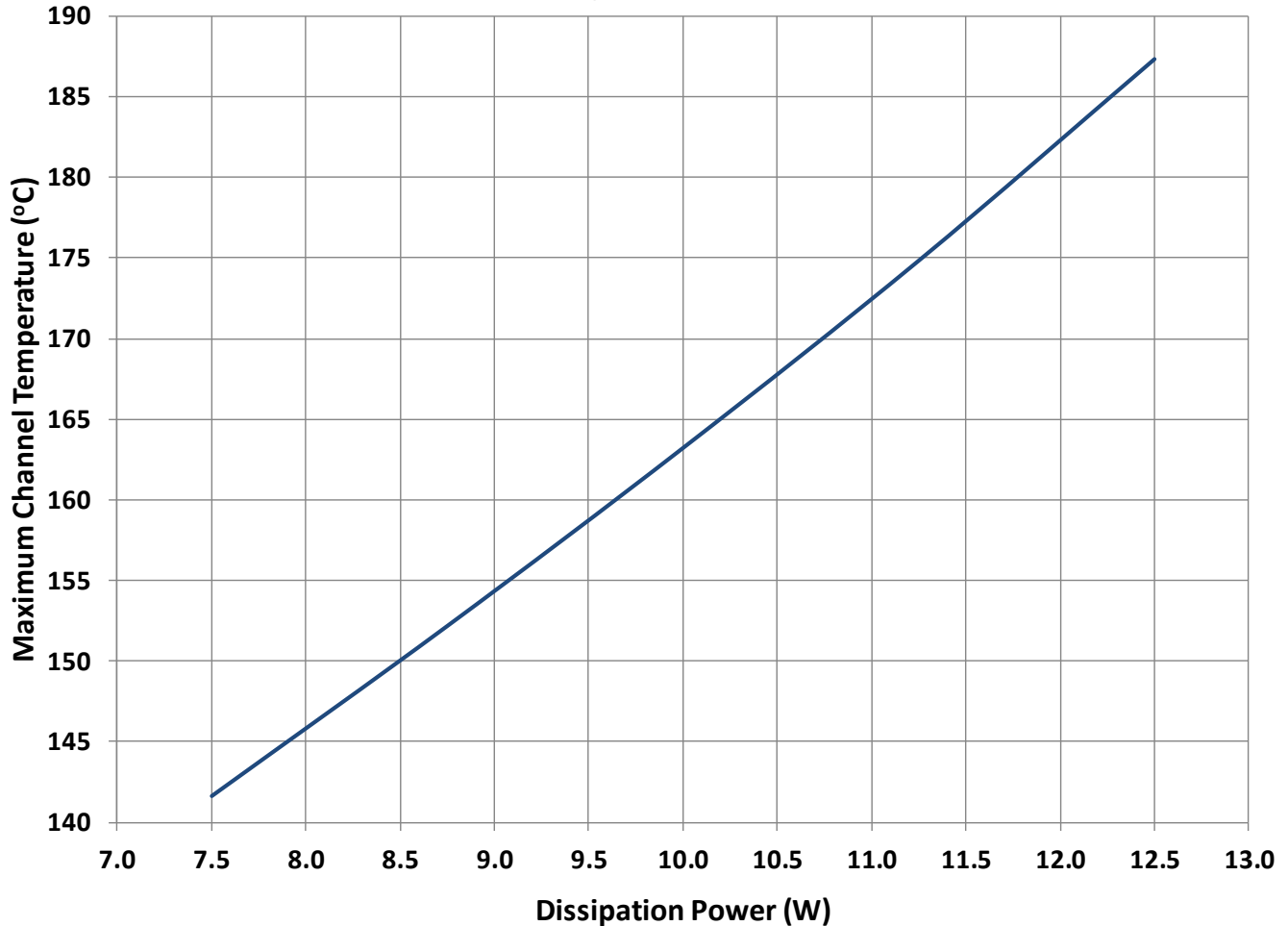

Parameter	Conditions	Values	Units
Thermal Resistance, IR ¹ (θ_{JC})	85 °C back side temperature	7.6	°C/W
Peak IR Surface Temperature ¹ (T_{CH})	7.5 W P_D	142	°C
Thermal Resistance, IR ¹ (θ_{JC})	85 °C back side temperature	7.7	°C/W
Peak IR Surface Temperature ¹ (T_{CH})	8.75 W P_D	152	°C
Thermal Resistance, IR ¹ (θ_{JC})	85 °C back side temperature	7.8	°C/W
Peak IR Surface Temperature ¹ (T_{CH})	10.0 W P_D	163	°C
Thermal Resistance, IR ¹ (θ_{JC})	85 °C back side temperature	8.0	°C/W
Peak IR Surface Temperature ¹ (T_{CH})	11.25 W P_D	175	°C
Thermal Resistance, IR ¹ (θ_{JC})	85 °C back side temperature	8.2	°C/W
Peak IR Surface Temperature ¹ (T_{CH})	12.5 W P_D	187	°C

Notes:

1. Refer to the following document [GaN Device Channel Temperature, Thermal Resistance, and Reliability Estimates](#)

Load Pull Contours^{1, 2}

Notes:

1. $V_D = 28\text{ V}$, $I_{DQ} = 50\text{ mA}$, Pulse Width = 100 μs . Duty Cycle = 20%. Performance is at 3dB gain compression referenced to peak gain.
2. See page 20 for load-pull and source-pull reference planes. 50 Ω load-pull TRL fixtures are built with 20 mils RO4350B material.

1GHz, Load-pull

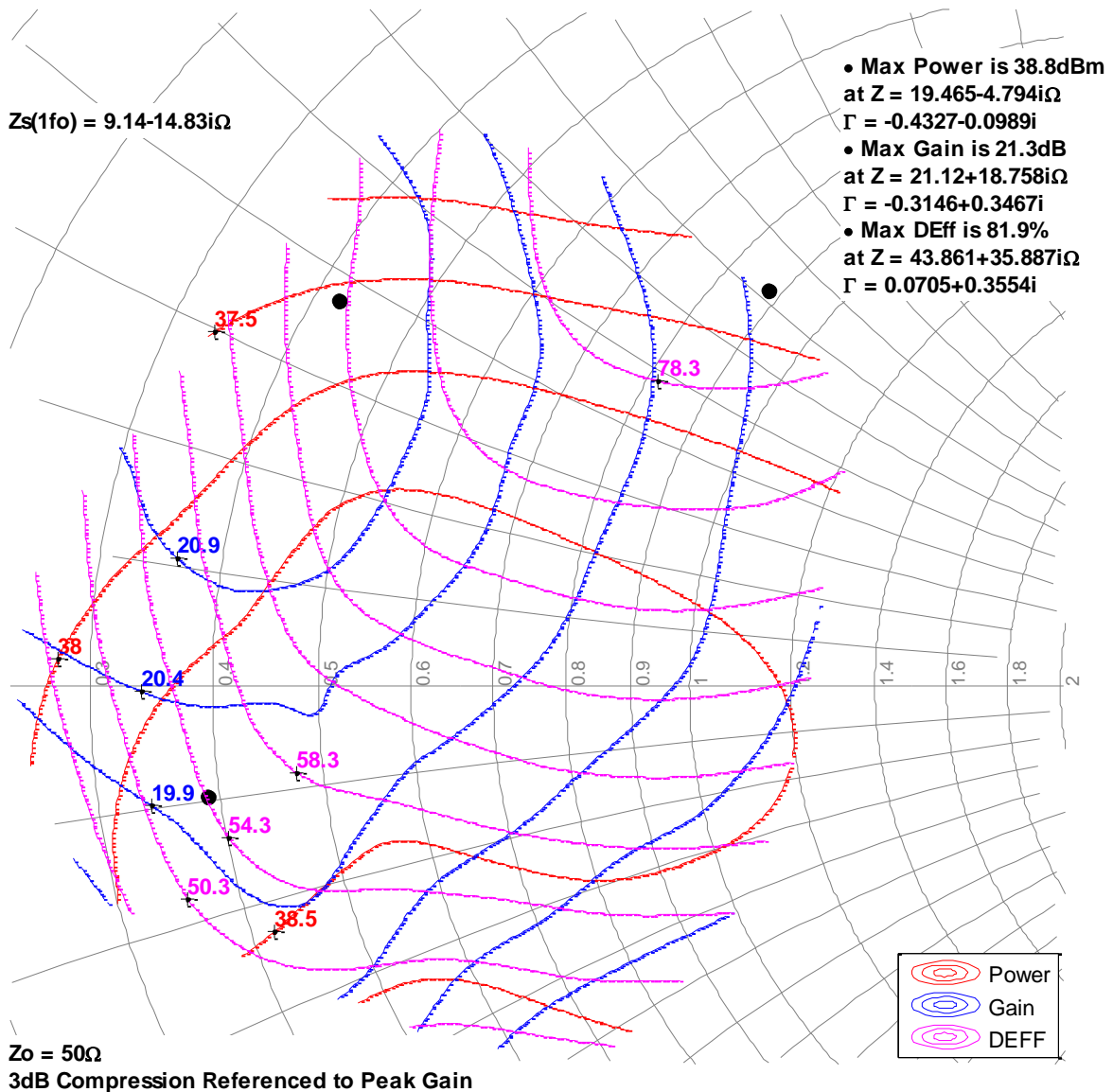

Load Pull Contours^{1, 2}

Notes:

1. $V_D = 28\text{ V}$, $I_{DQ} = 50\text{ mA}$, Pulse Width = 100 μs . Duty Cycle = 20%. Performance is at 3dB gain compression referenced to peak gain.
2. See page 20 for load-pull and source-pull reference planes. 50 Ω load-pull TRL fixtures are built with 20 mils RO4350B material.

2GHz, Load-pull

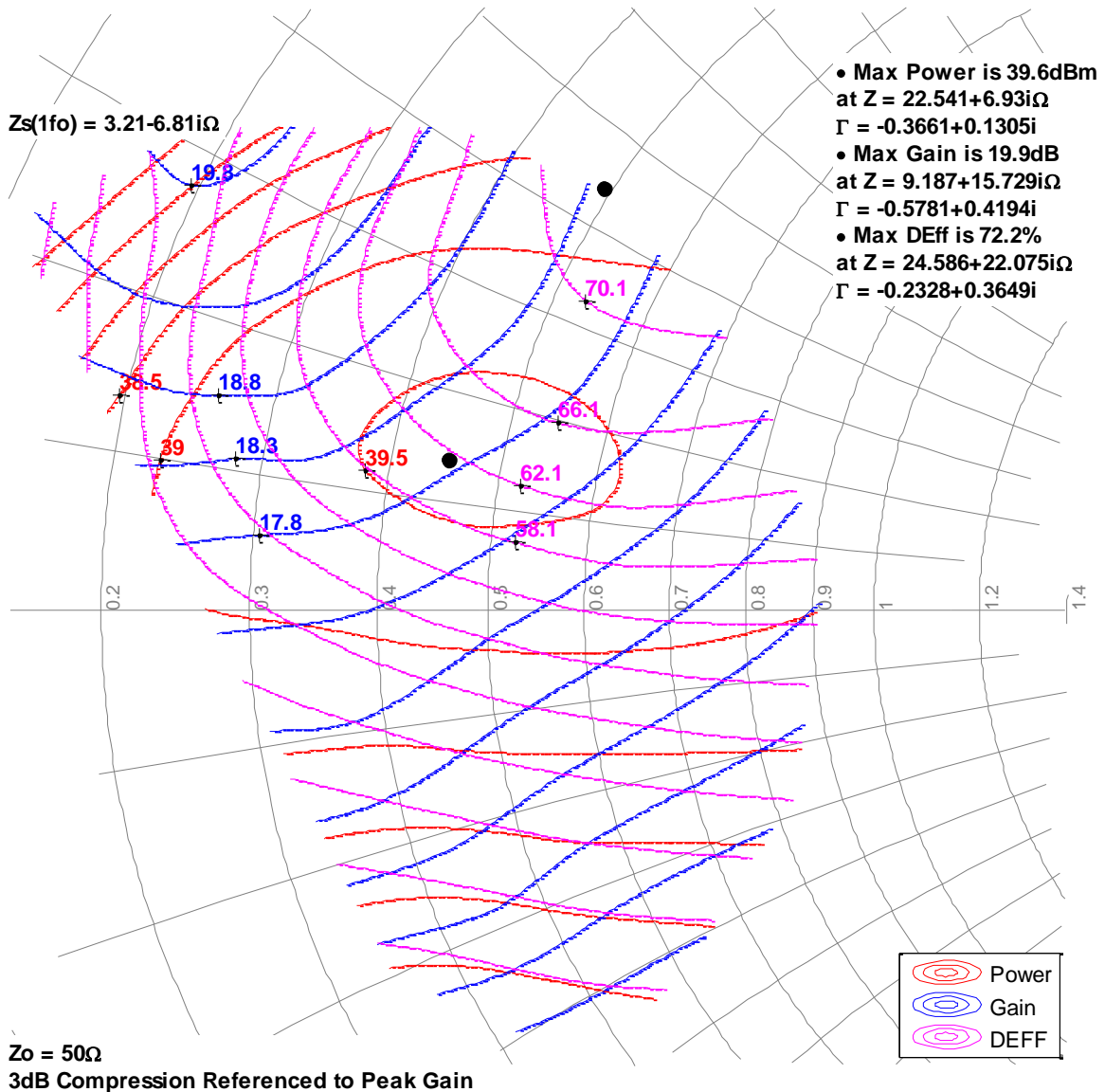

Load Pull Contours^{1, 2}

Notes:

1. $V_D = 28\text{ V}$, $I_{DQ} = 50\text{ mA}$, Pulse Width = 100 μs . Duty Cycle = 20%. Performance is at 3dB gain compression referenced to peak gain.
2. See page 20 for load-pull and source-pull reference planes. 50 Ω load-pull TRL fixtures are built with 20 mils RO4350B material.

3GHz, Load-pull

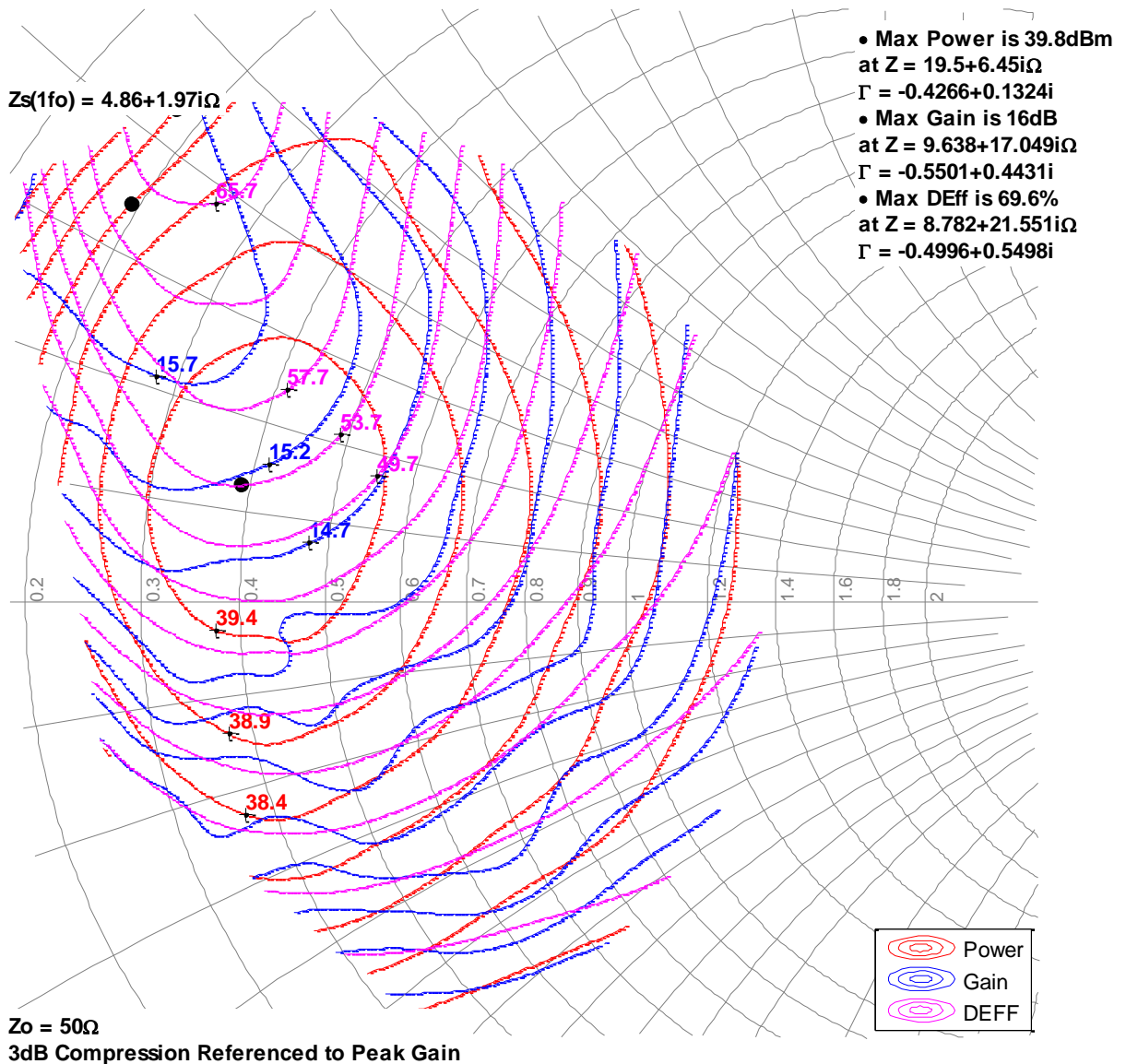

Load Pull Contours^{1, 2}

Notes:

1. $V_D = 28\text{ V}$, $I_{DQ} = 50\text{ mA}$, Pulse Width = 100 μs . Duty Cycle = 20%. Performance is at 3dB gain compression referenced to peak gain.
2. See page 20 for load-pull and source-pull reference planes. 50 Ω load-pull TRL fixtures are built with 20 mils RO4350B material.

4GHz, Load-pull

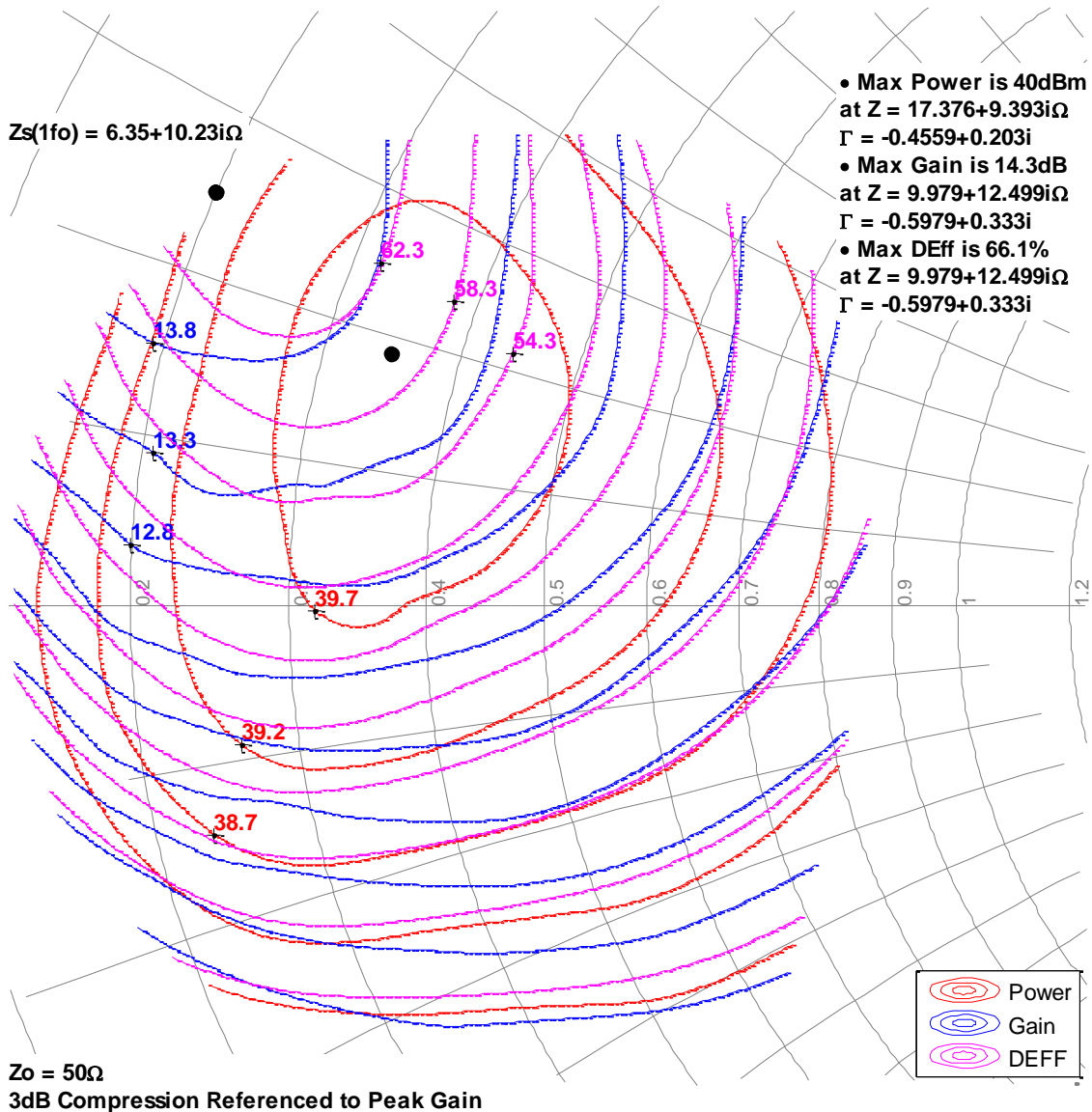

Load Pull Contours^{1, 2}

Notes:

1. $V_D = 28\text{ V}$, $I_{DQ} = 50\text{ mA}$, Pulse Width = 100 μs . Duty Cycle = 20%. Performance is at 3dB gain compression referenced to peak gain.
2. See page 20 for load-pull and source-pull reference planes. 50 Ω load-pull TRL fixtures are built with 20 mils RO4350B material.

5GHz, Load-pull

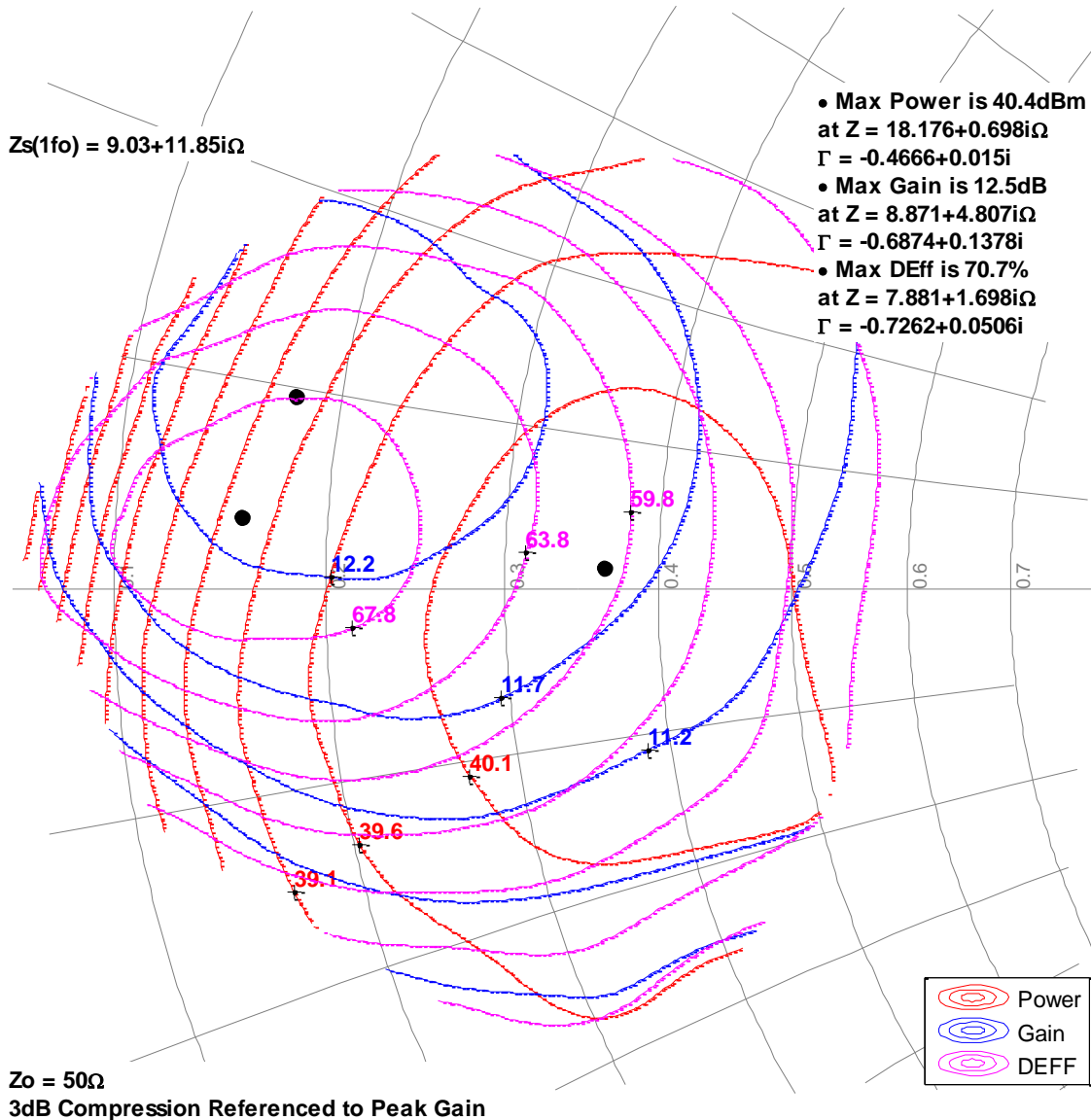

Load Pull Contours^{1, 2}

Notes:

1. $V_D = 28\text{ V}$, $I_{DQ} = 50\text{ mA}$, Pulse Width = 100 μs . Duty Cycle = 20%. Performance is at 3dB gain compression referenced to peak gain.
2. See page 20 for load-pull and source-pull reference planes. 50 Ω load-pull TRL fixtures are built with 20 mils RO4350B material.

6GHz, Load-pull

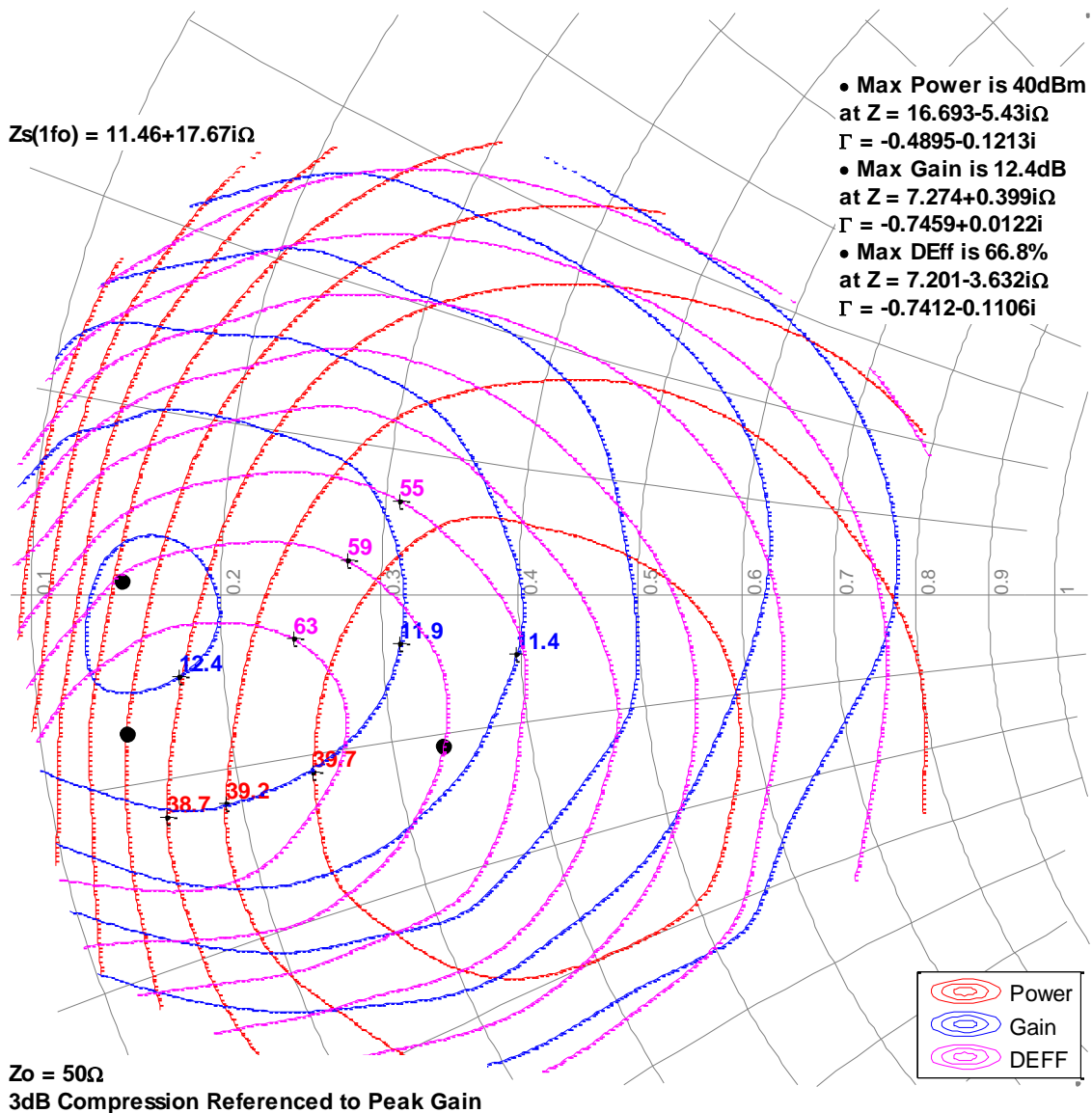

Typical Performance – Load-Pull Drive-up^{1, 2}

Notes:

1. Pulse Width = 100 μ s, Duty Cycle = 20%, $V_D = 28$ V, $I_{DQ} = 50$ mA
2. See page 20 for load-pull and source-pull reference planes where the performance was measured.

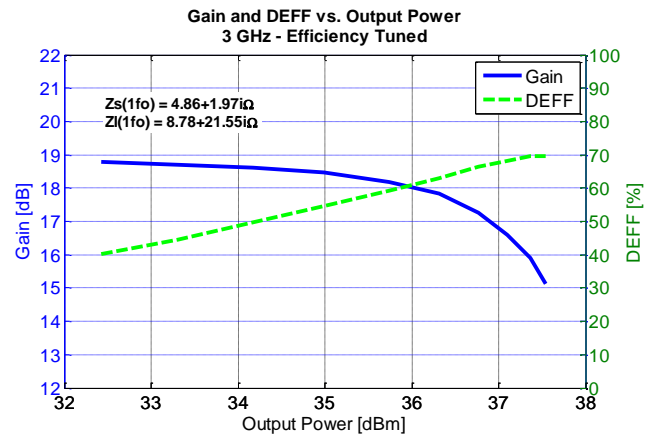
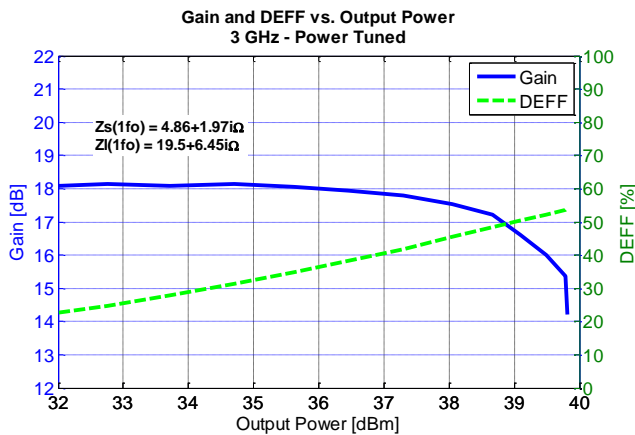
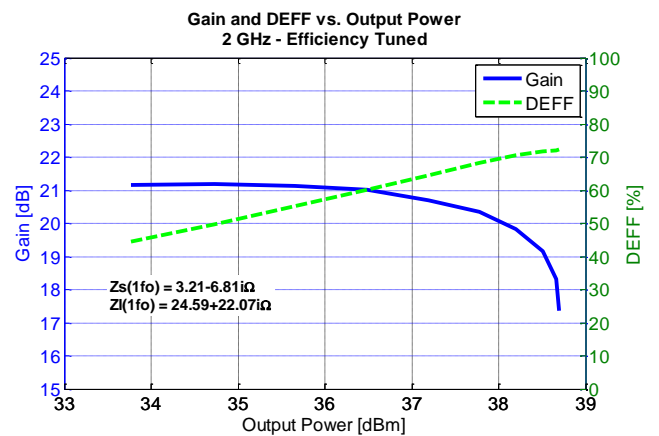
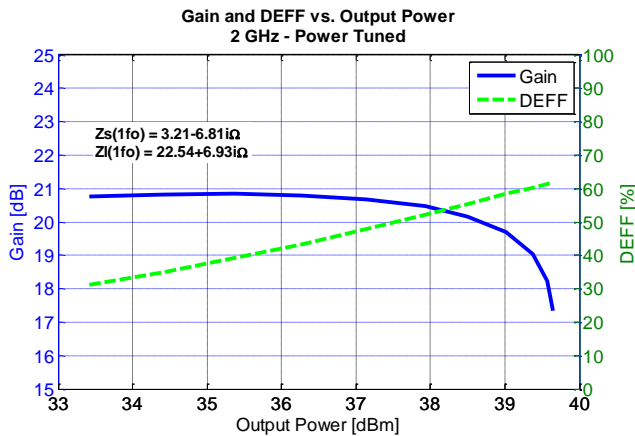
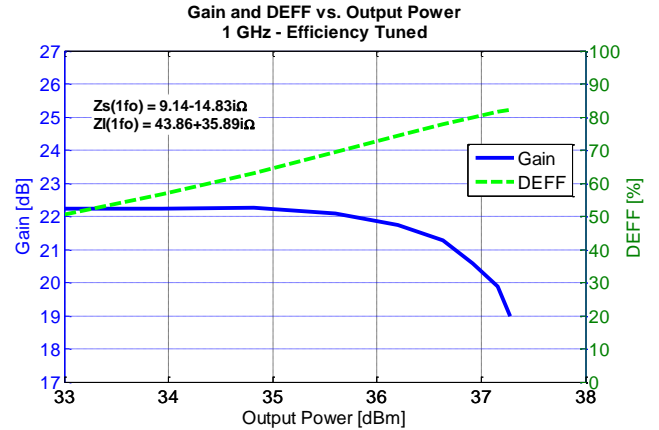
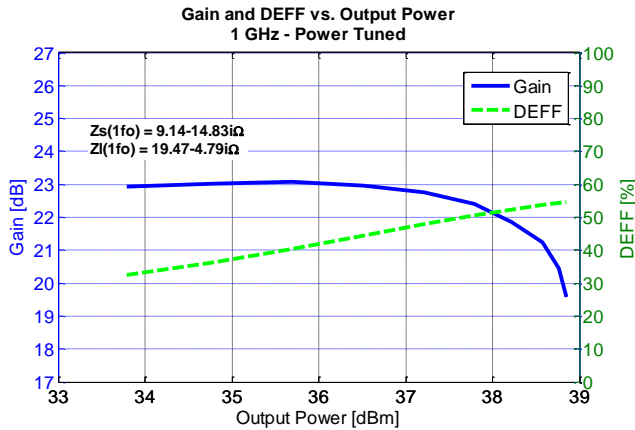

Typical Performance – Load-Pull Drive-up^{1, 2}

Notes:

1. Pulse Width = 100 μ s, Duty Cycle = 20%, $V_D = 28$ V, $I_{DQ} = 50$ mA
2. See page 20 for load-pull and source-pull reference planes where the performance was measured.

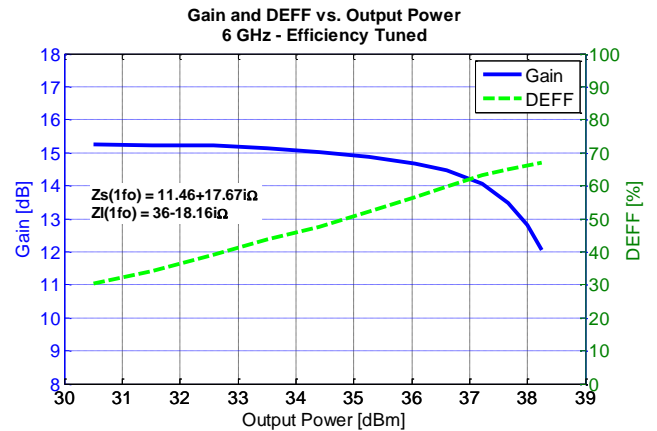
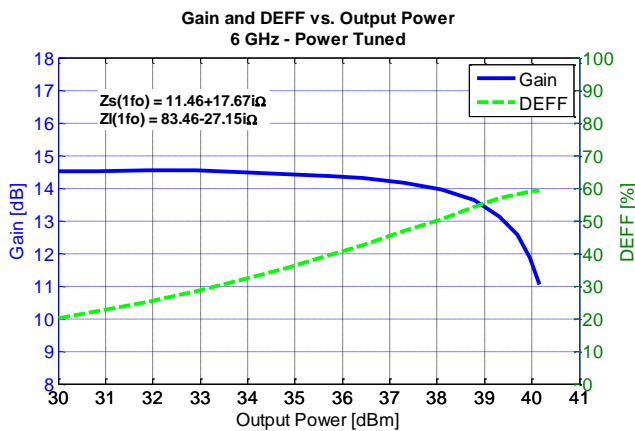
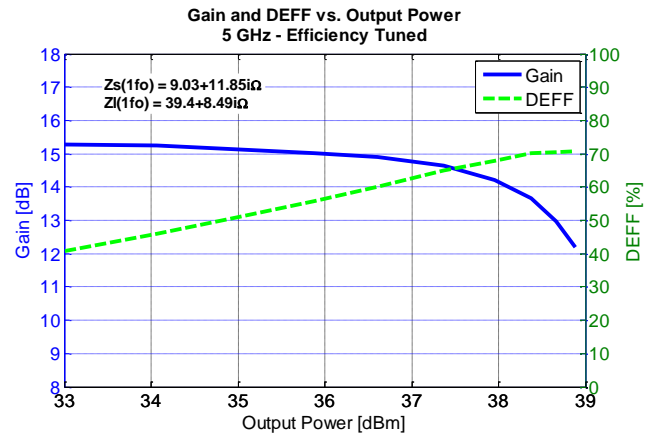
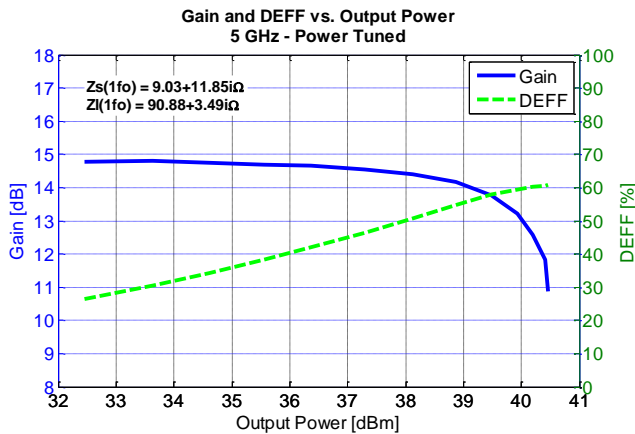
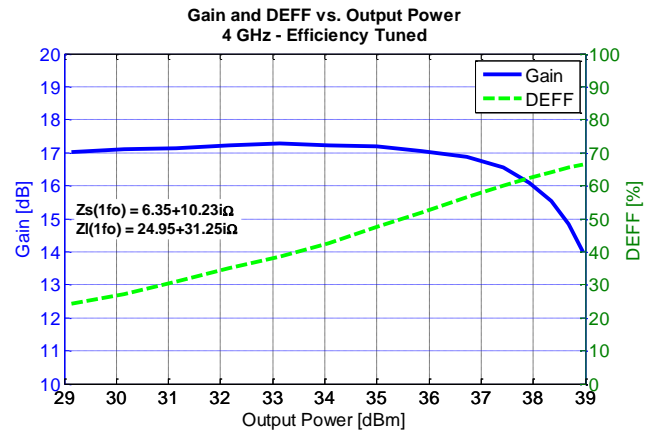
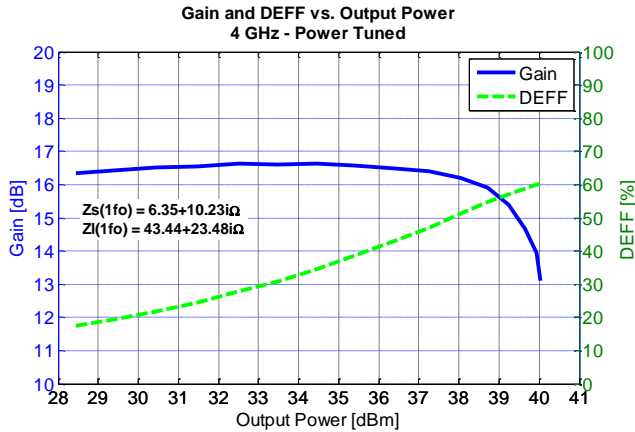

Power Drive-Up Performance Over Temperatures of 3.0 – 3.5 GHz EVB¹

Notes:

1. Pulse Width = 100 μ s, Duty Cycle = 20%, $V_D = 28$ V, $I_{DQ} = 50$ mA

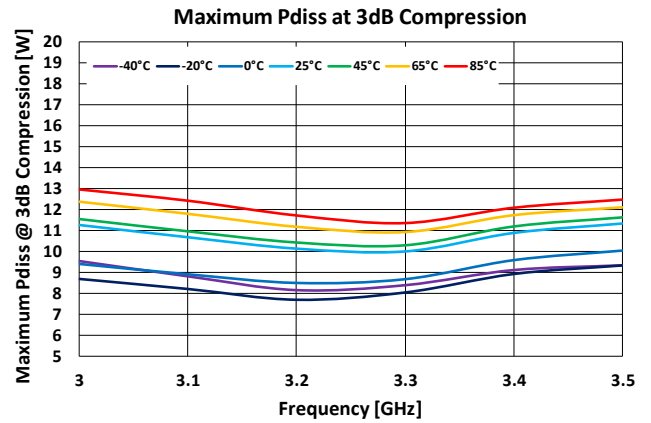
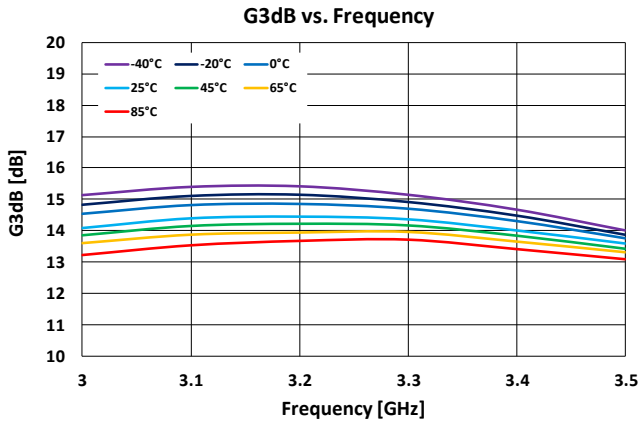
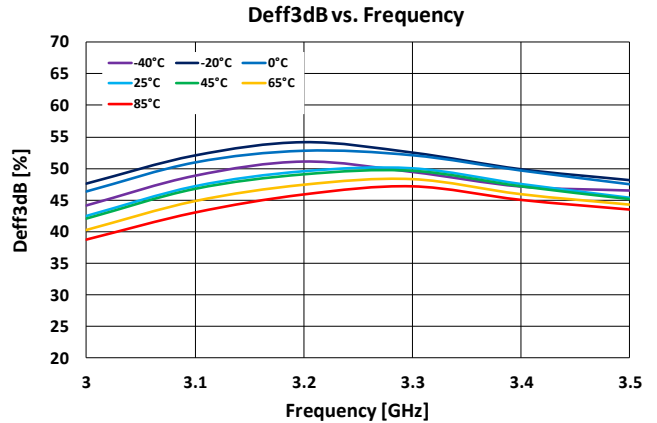
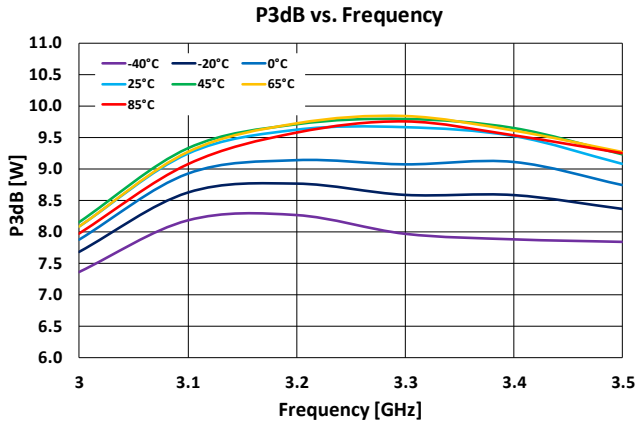

Power Drive-Up Performance at 25 °C of 3.0 – 3.5 GHz EVB¹

Notes:

1. Pulse Width = 100 μ s, Duty Cycle = 20%, V_D = 28 V, I_{DQ} = 50 mA

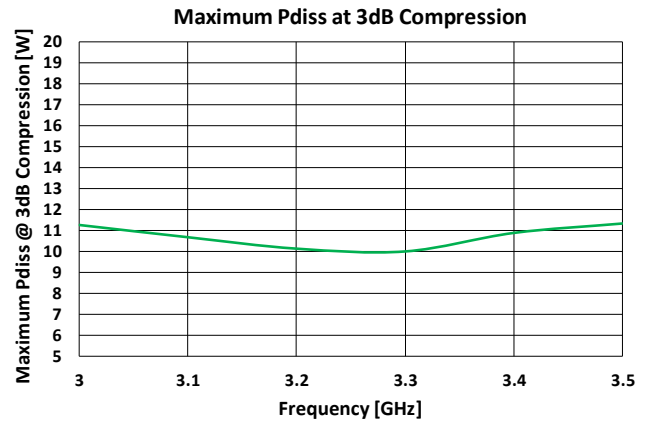
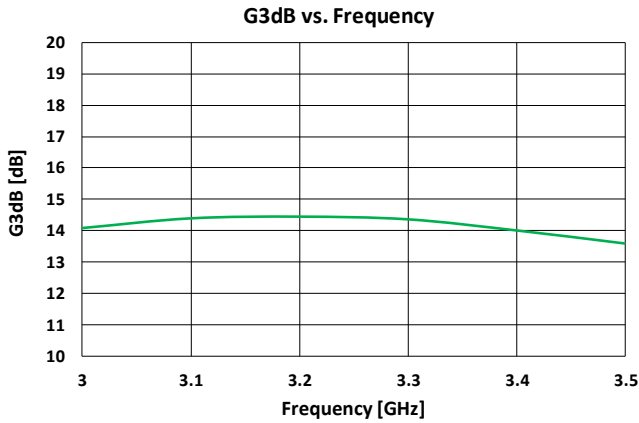
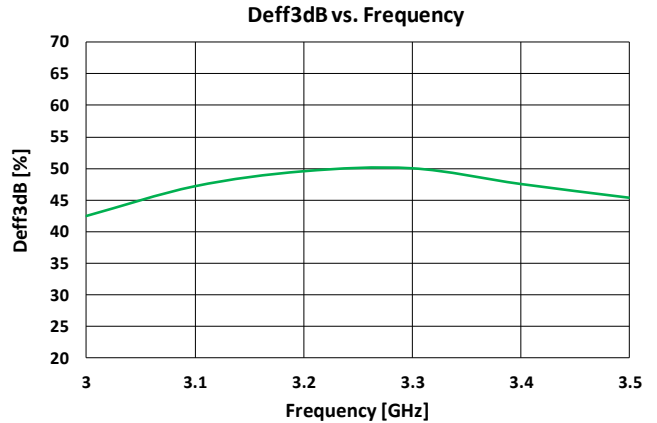
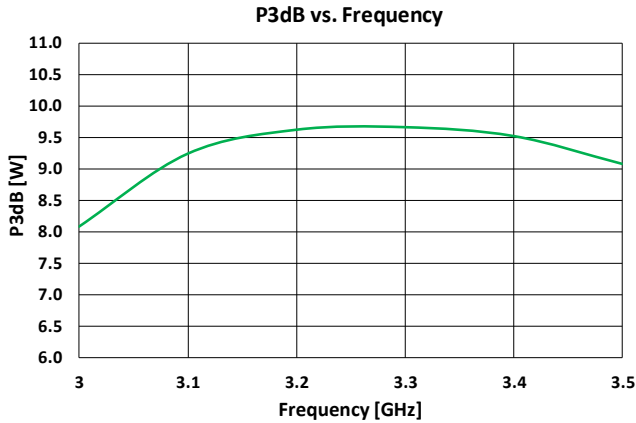

Power Drive-Up Performance at 25 °C of 1.9 – 3.2 GHz EVB¹

Notes:

1. Pulse Width = 100 μ s, Duty Cycle = 20%, V_D = 28 V, I_{DQ} = 50 mA

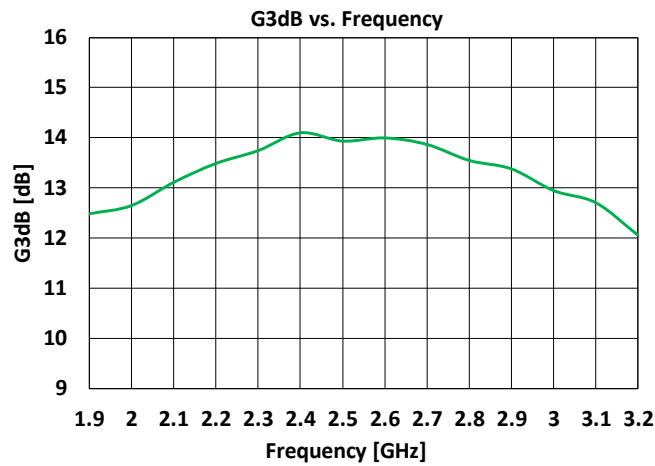
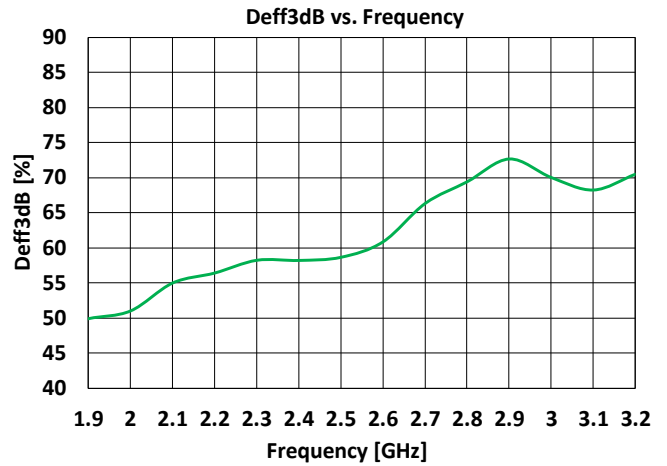
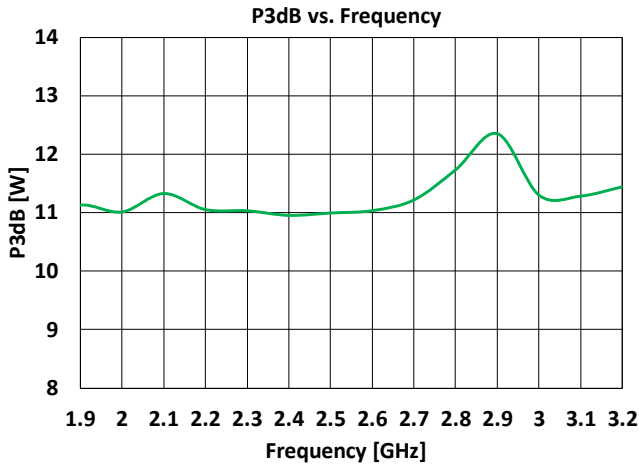

Power Drive-Up Performance at 25 °C of 3.5 – 4.3 GHz EVB¹

Notes:

1. Pulse Width = 100 μ s, Duty Cycle = 20%, V_D = 28 V, I_{DQ} = 50 mA

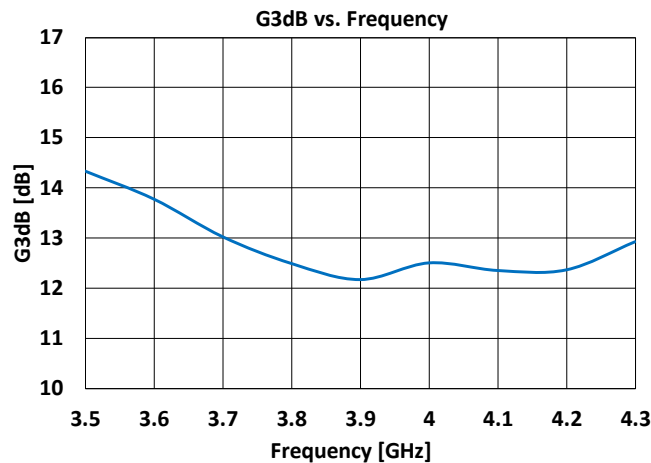
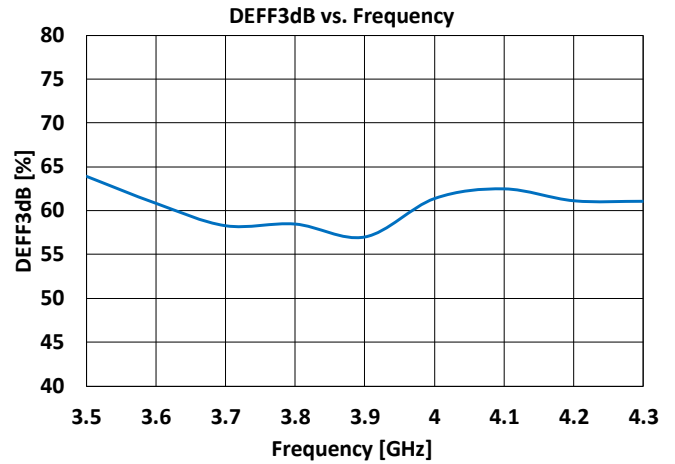
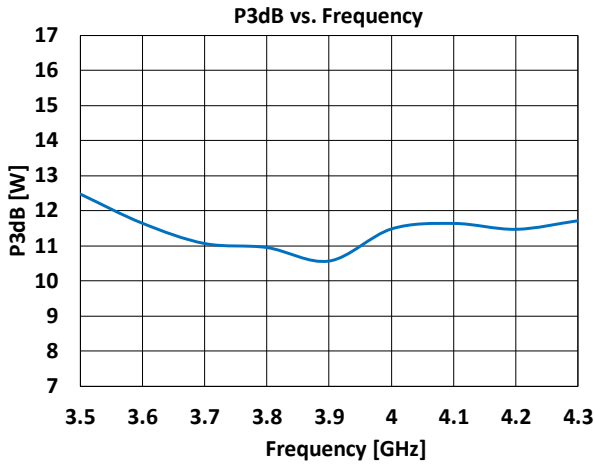

Power Drive-Up Performance at 25 °C of 5 – 6 GHz EVB¹

Notes:

1. Pulse Width = 100 μ s, Duty Cycle = 20%, V_D = 32 V, I_{DQ} = 50 mA

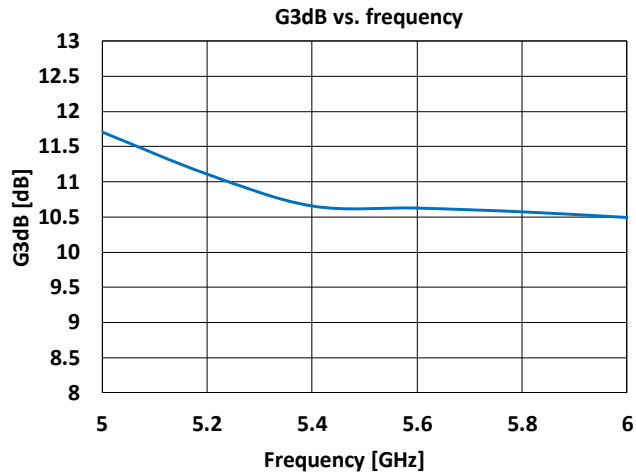
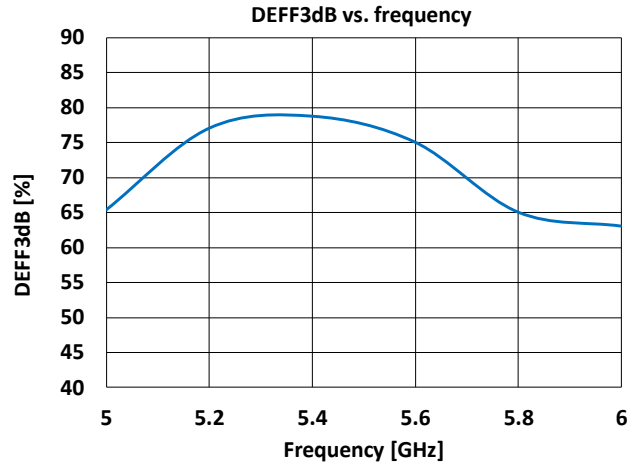
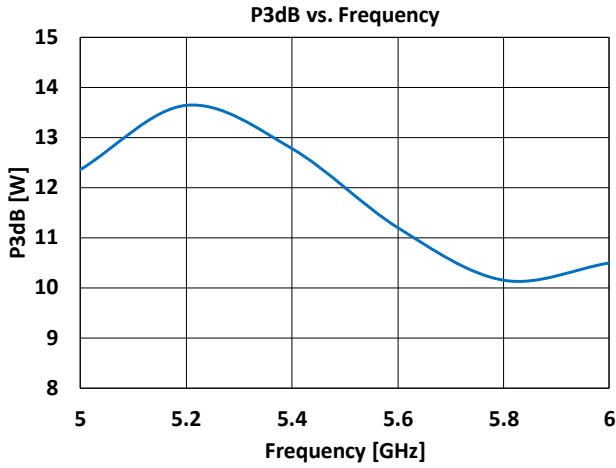

Pin Configuration and Package Marking¹

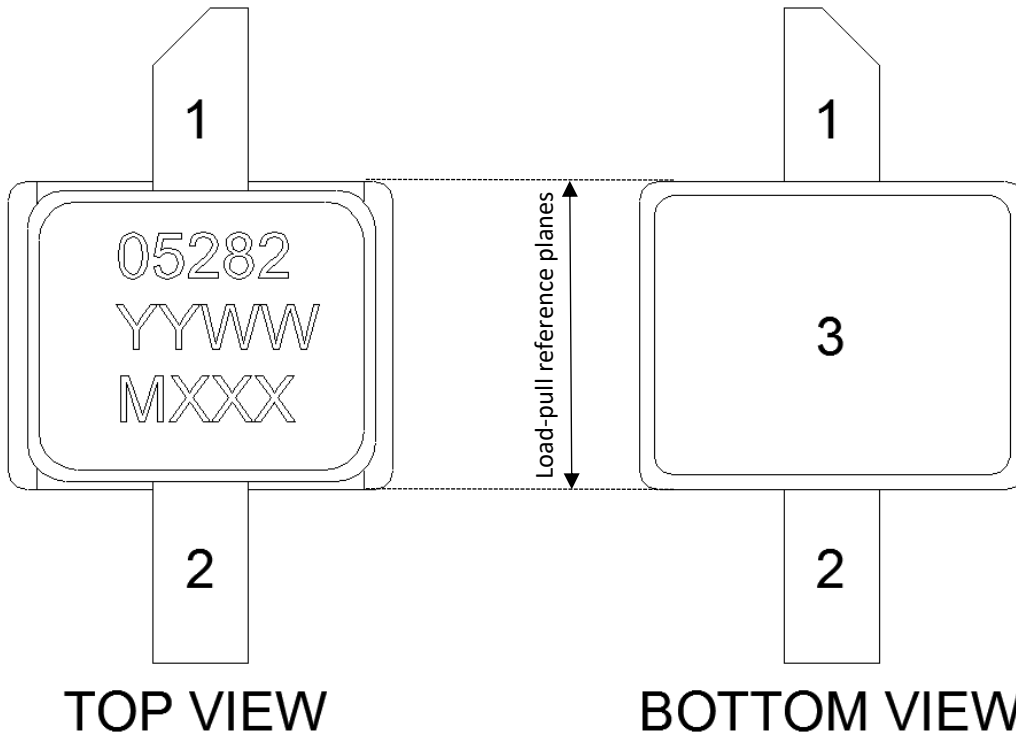

Pin	Symbol	Description
1	V_D / RF_{OUT}	Gate Voltage / RF Input
2	V_G / RF_{IN}	Drain Voltage / RF Output
3	GND	Package base/ Ground

Notes:

- The T2G6000528-Q3 will be marked with the “05282” designator and a lot code marked below the part designator. The “YY” represents the last two digits of the calendar year the part was manufactured, the “WW” is the work week of the assembly lot start, the “MXXX” is the production lot number.

Package Dimensions^{1, 2, 3, 4, 5, 6}

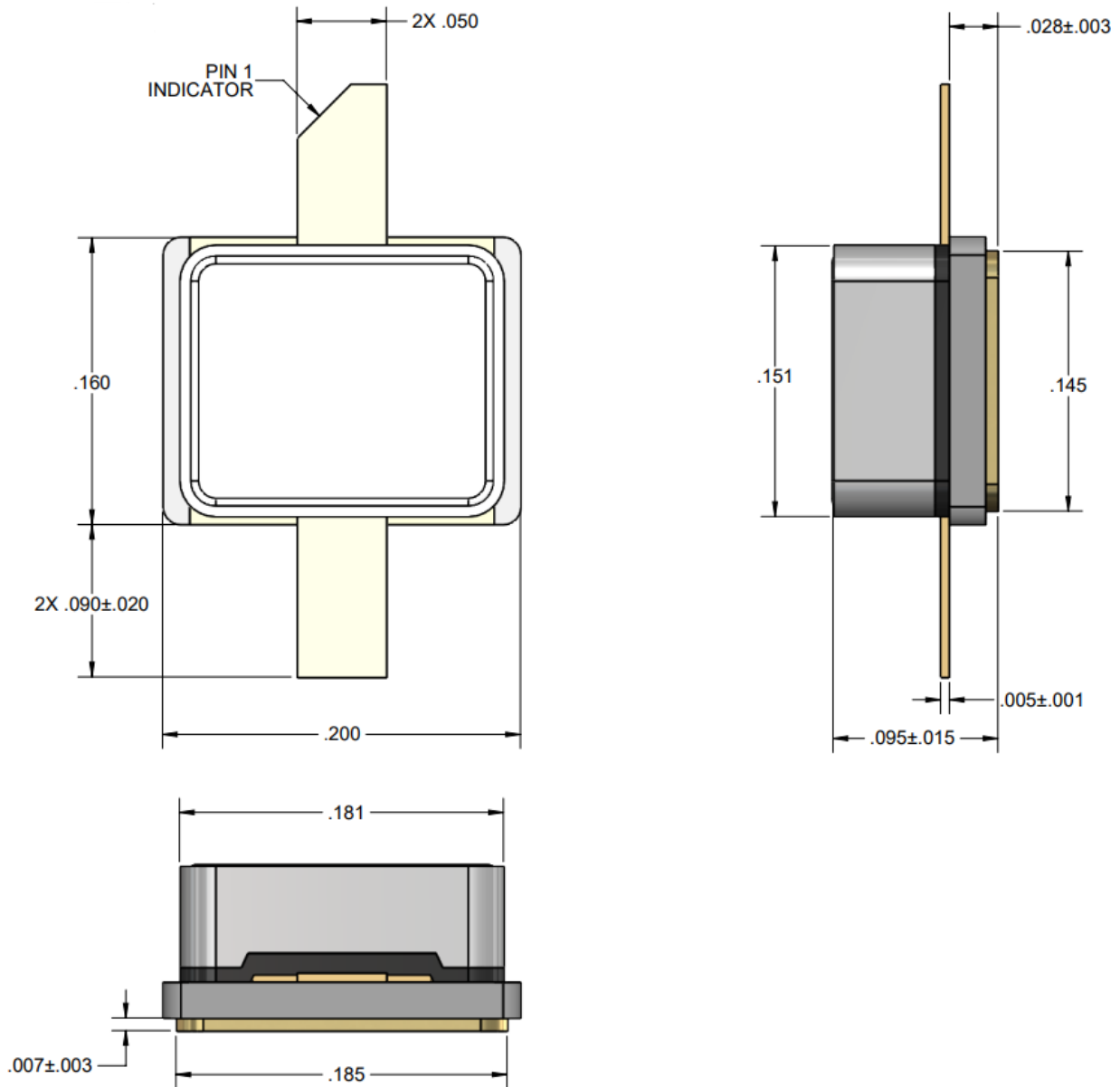

Notes:

1. Unless otherwise specified, dimensions are in inches.
2. Material:
 Package Base: Ceramic/Metal
 Package Lid: Ceramic
3. Package exposed metal base and leads are gold plated.
4. Part is epoxy sealed.
5. Part meets industry NI200 footprint.
6. Body Dimensions do not include lid shift or epoxy run out which can be up to 0.020 per side.

Schematic of 3.0 – 3.5 GHz EVB

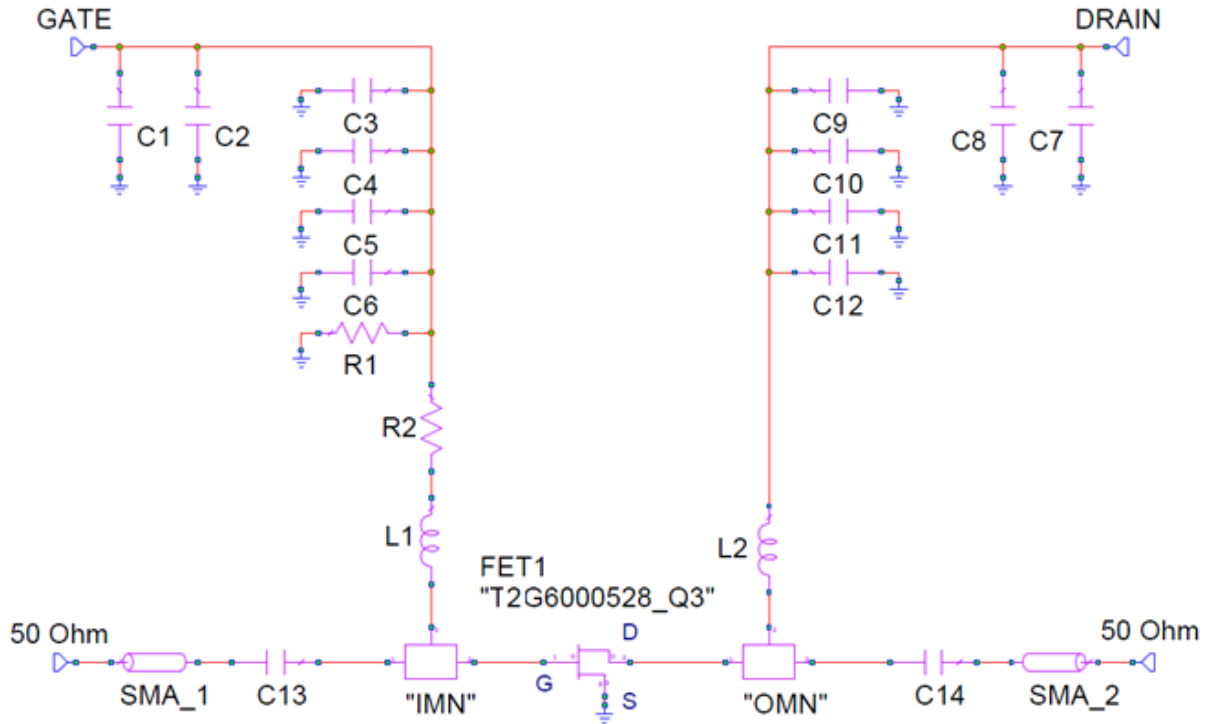

Bias-up Procedure	Bias-down Procedure
1. Set V_G to -4 V	1. Turn off RF signal.
2. Set I_D current limit to 60 mA.	2. Turn off V_D .
3. Set V_D to 28 V.	3. Wait 2 seconds to allow drain capacitor to discharge
4. Slowly adjust V_G until I_D is set to 50 mA.	4. Turn off V_G
5. Set I_D current limit to 0.7 A.	
6. Apply RF.	

Layout of 3.0 – 3.5 GHz EVB^{1, 2, 3}

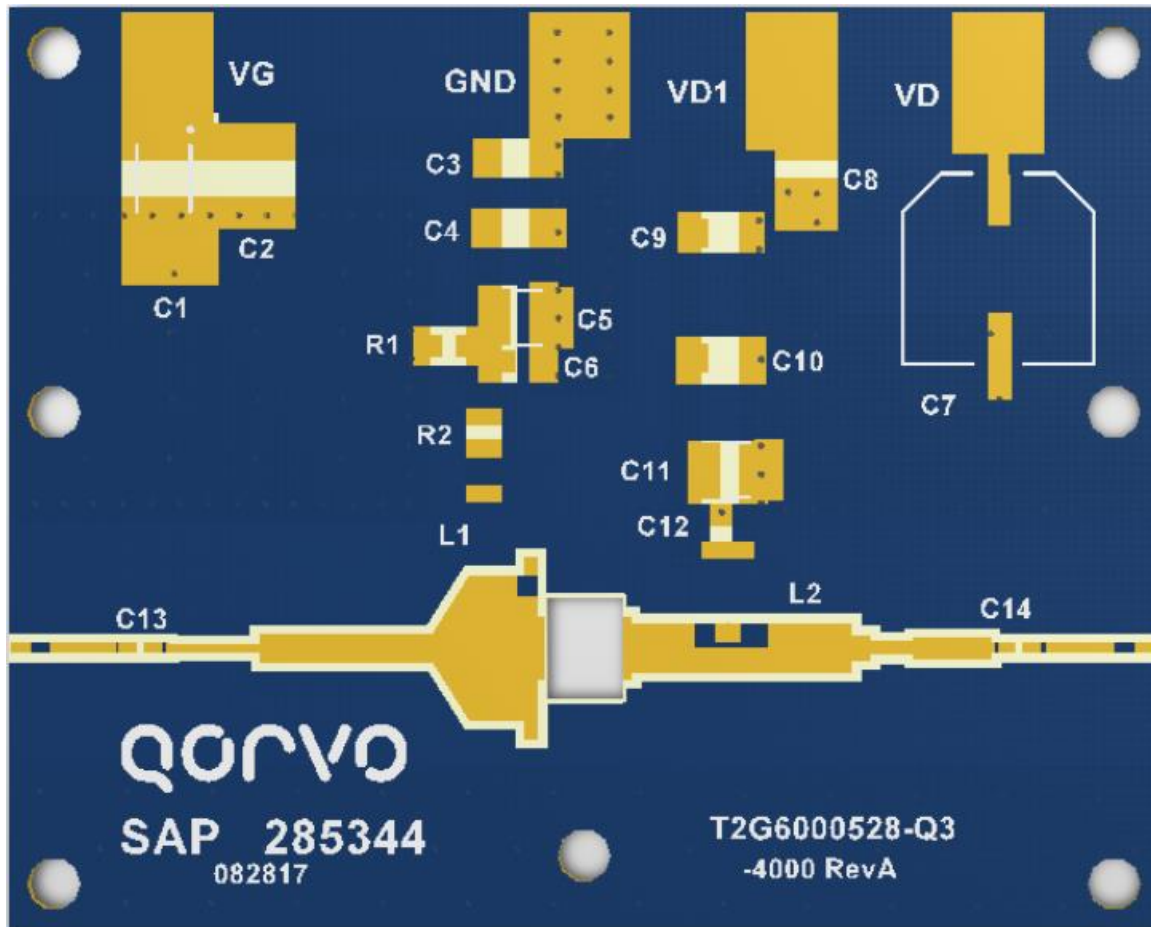

Notes:

1. PCB Material: RO4350B, 20 mil thickness, 1 oz copper cladding
2. Overall size is 2 x 2.5 inch².
3. Connect 28 V to V_D port and insert a current sensor for current measurement between V_{D1} and V_D ports.

Bill of Material – 3.0 – 3.5 GHz EVB

Ref Des	Value	Qty	Manufacturer	Part Number
C1, C7	22 uF	2	Sprague	T491D
C2, C8	1 uF	2	Kemet	1812C105KAT2A
C3, C9	0.1 uF	2	Kemet	C1206C104KRAC7800
C4, C10	0.01 uF	2	Kemet	C1206C103KRAC7800
C5, C11	100 pF	2	ATC	100B101
C6, C12	2400 pF	2	DLI	C08BL242C5UNC0B
C13, C14	27 pF	2	ATC	600L270JT200
R1	1000 ohm	1	Vishay Dale	CRCW0805100F100
R2	12 ohm	1	Vishay Dale	RM73B2B120J
L1, L2	9.85 nH	2	Coilcraft	16069JLB

Schematic of 1.9 – 3.2 GHz EVB

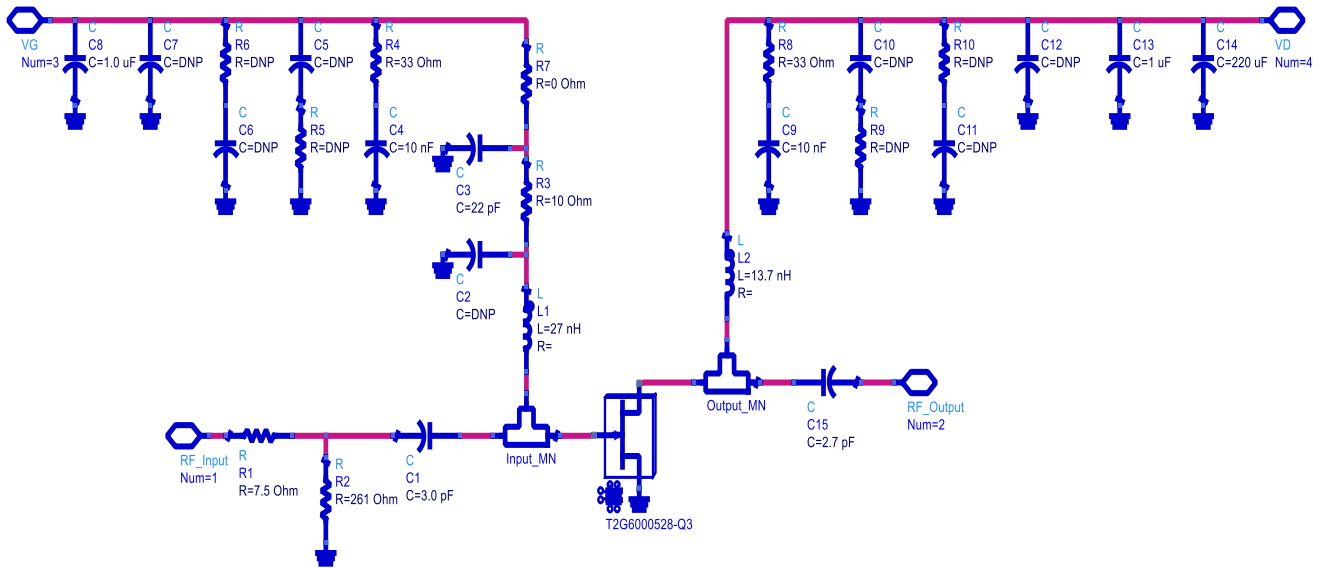

Bias-up Procedure	Bias-down Procedure
2. Set V_G to -4 V	3. Turn off RF signal.
4. Set I_D current limit to 60 mA.	4. Turn off V_D .
5. Set V_D to 28 V.	5. Wait 2 seconds to allow drain capacitor to discharge
6. Slowly adjust V_G until I_D is set to 50 mA.	7. Turn off V_G
8. Set I_D current limit to 0.7 A.	
9. Apply RF.	

Layout of 1.9 – 3.2 GHz EVB^{1, 2, 3}

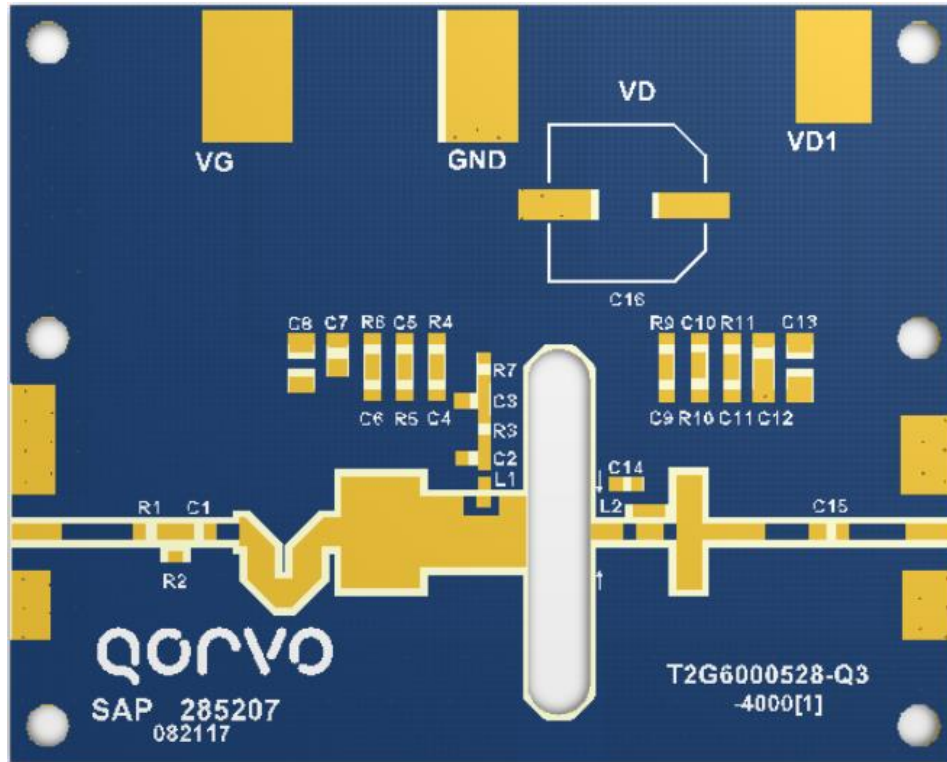

Notes:

1. PCB Material: RO4350B, 20 mil thickness, 1 oz copper cladding
2. Overall size is 2 x 2.5 inch².
3. Connect 28 V to V_D port and insert a current sensor for current measurement between V_{D1} and V_D ports.

Bill of Material – 1.9 – 3.2 GHz EVB

Ref Des	Value	Qty	Manufacturer	Part Number
C1	3.0 pF	1	PPI	0603N3R0AW251X
C3, C14	22 pF	2	ATC	600S220FT250XT
C4, C9	10 nF	2	Capax	0603X103K101S
C8, C13	1 uF	2	TTI	C1206T105J5RACTU
C15	2.7 pF	1	ATC	600S2R7AW250XT
C16	47 uF	1	Panasonic	EEETG1K470UP
L1	27 nH	1	Coilcraft	0603CS-27NXGEW
L2	13.7 nH	1	Coilcraft	0807SQ-14NJLB
R1	7.5 Ohm	1	TTI	CRCW06037R50FKEA
R2	270 Ohm	1	TTI	RK73B1JTTD271J
R3	10 Ohm	1	TTI	CRCW060310R0JNTA
R4, R9	33.2 Ohm	2	TTI	CRCW060333R2FKTA
R7	0 Ohm	1	TTI	ERJ-3GEY0R00V
C5, C6, C7, C10, C11, C12, R5, R6, R10, R11	DNP			

Schematic of 3.5 – 4.3 GHz EVB

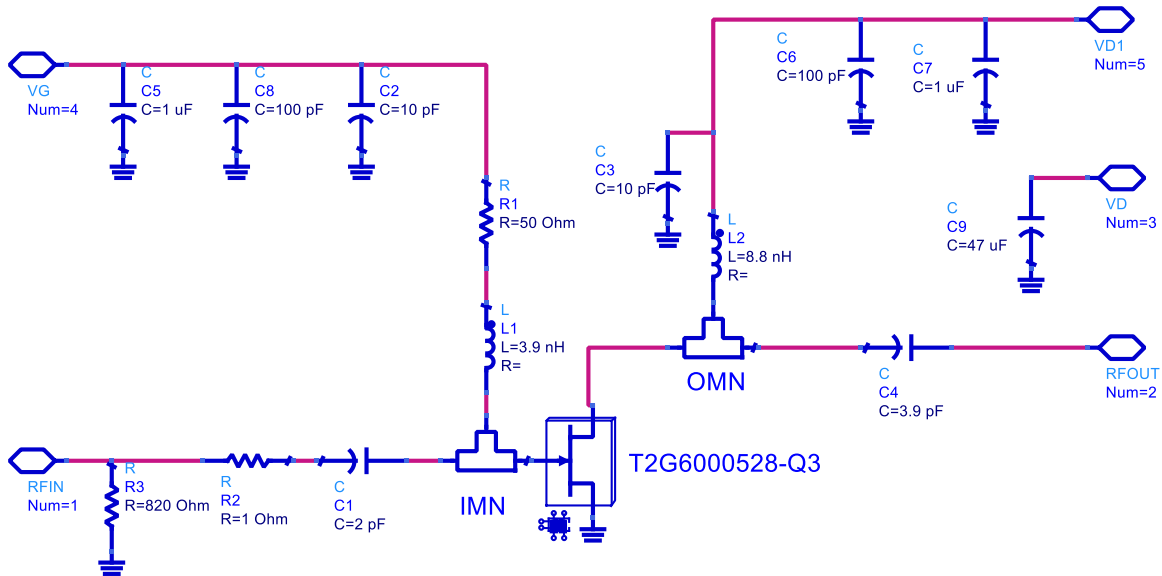

Bias-up Procedure	Bias-down Procedure
3. Set V_G to -4 V	5. Turn off RF signal.
6. Set I_D current limit to 60 mA.	6. Turn off V_D .
7. Set V_D to 28 V.	7. Wait 2 seconds to allow drain capacitor to discharge
8. Slowly adjust V_G until I_D is set to 50 mA.	10. Turn off V_G
11. Set I_D current limit to 0.7 A.	
12. Apply RF.	

Layout of 3.5 – 4.3 GHz EVB^{1, 2, 3}

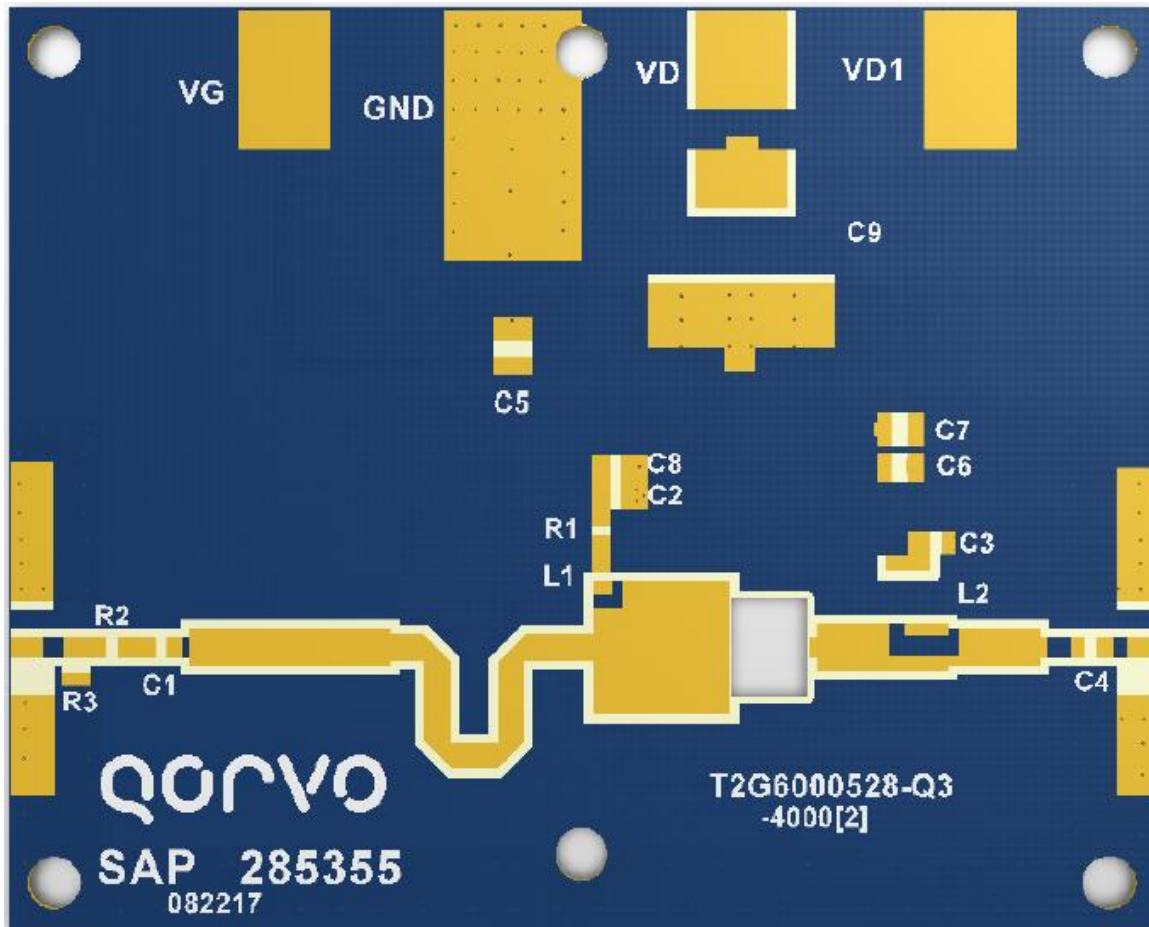

Notes:

1. PCB Material: RO4350B, 20 mil thickness, 1 oz copper cladding
2. Overall size is 2 x 2.5 inch².
3. Connect 28 V to V_D port and insert a current sensor for current measurement between V_{D1} and V_D ports.

Bill of Material – 3.5 – 4.3 GHz EVB

Ref Des	Value	Qty	Manufacturer	Part Number
C1	2 pF	1	ATC	600S2R0AT250X
C4	3.9 pF	1	ATC	600S3R9AT250X
C2, C3	10 pF	2	ATC	600S100FT250XT
C6, C8	100 pF	2	Capax	0603G101J201S
C5, C7	1 uF	2	TTI	C0805C105K5RACTU
C9	47 uF	1	Digikey	EEETG1K470UP
L1	3.9 nH	1	Coilcraft	0603CS-3N9XJEW
L2	8.8 nH	1	Coilcraft	1606-8GLB
R1	50 Ohm	1	Vishay	CRCW060350R0FKEA-ND
R2	1 Ohm	1	Vishay	RC1608F1ROCS
R3	866 Ohm	1	Vishay	CRCW0603866RFKEA

Schematic of 5 – 6 GHz EVB

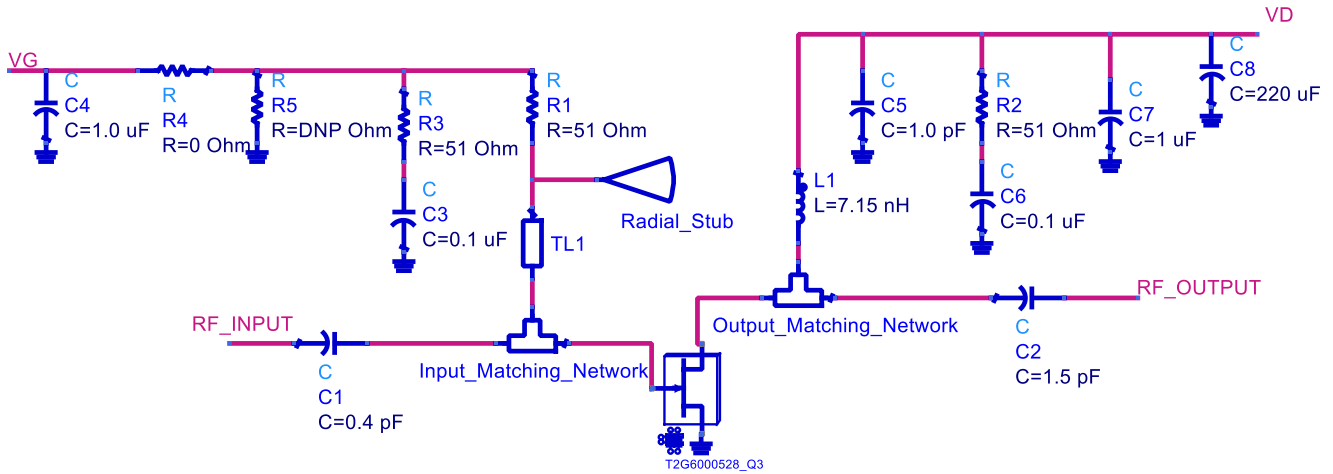

Bias-up Procedure	Bias-down Procedure
4. Set V_G to -4 V	7. Turn off RF signal.
8. Set I_D current limit to 60 mA.	8. Turn off V_D .
9. Set V_D to 32 V.	9. Wait 2 seconds to allow drain capacitor to discharge
10. Slowly adjust V_G until I_D is set to 50 mA.	13. Turn off V_G
14. Set I_D current limit to 0.7 A.	
15. Apply RF.	

Layout of 5.0 – 6.0 GHz EVB^{1, 2, 3}

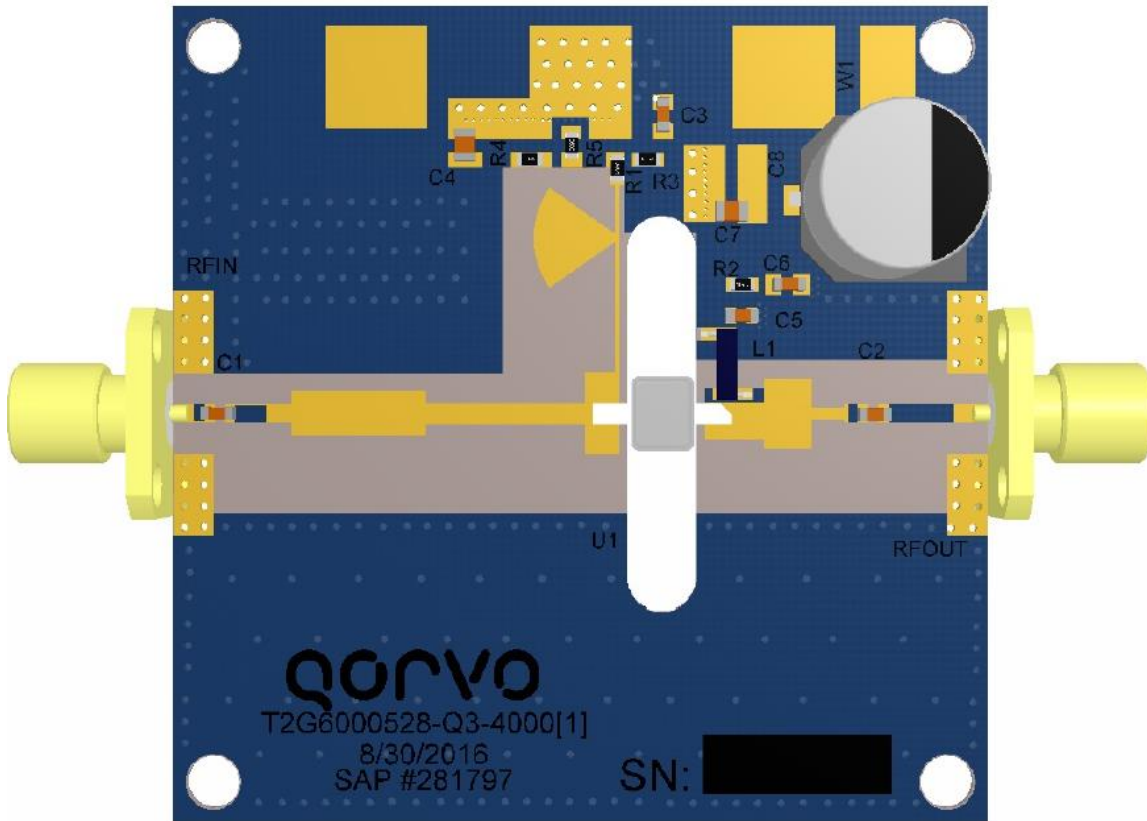

Notes:

1. PCB Material: RO4350B, 20 mil thickness, 1 oz copper cladding
2. Overall size is 2 x 2 inch².
3. Connect 32 V to V_D port.

Bill of Material – 5.0 – 6.0 GHz EVB

Ref Des	Value	Qty	Manufacturer	Part Number
C1	0.4 pF	1	ATC	600S0R4AT250X
C2	1.5 pF	1	ATC	600S1R5AT250X
C5	1 pF	1	ATC	600S1R0BT250XT
C3, C6	0.1 uF	2	TTI	C0603C104K5RAC
C4, C7	1 uF	2	Digikey	CGA4J3X7S2A105K125AB
C8	220 uF, 50 V	1	Panasonic	EEE-FK1H221GP
L1	5.6 nH	1	Coilcraft	1606-6GLC
R1, R2, R3	51 Ohm	3	Vishay	CRCW060351R1FKTA
R4	0 Ohm	1	Vishay	CRCW06030000Z0EA
R5	DNP	1		

Recommended Solder Temperature Profile

